

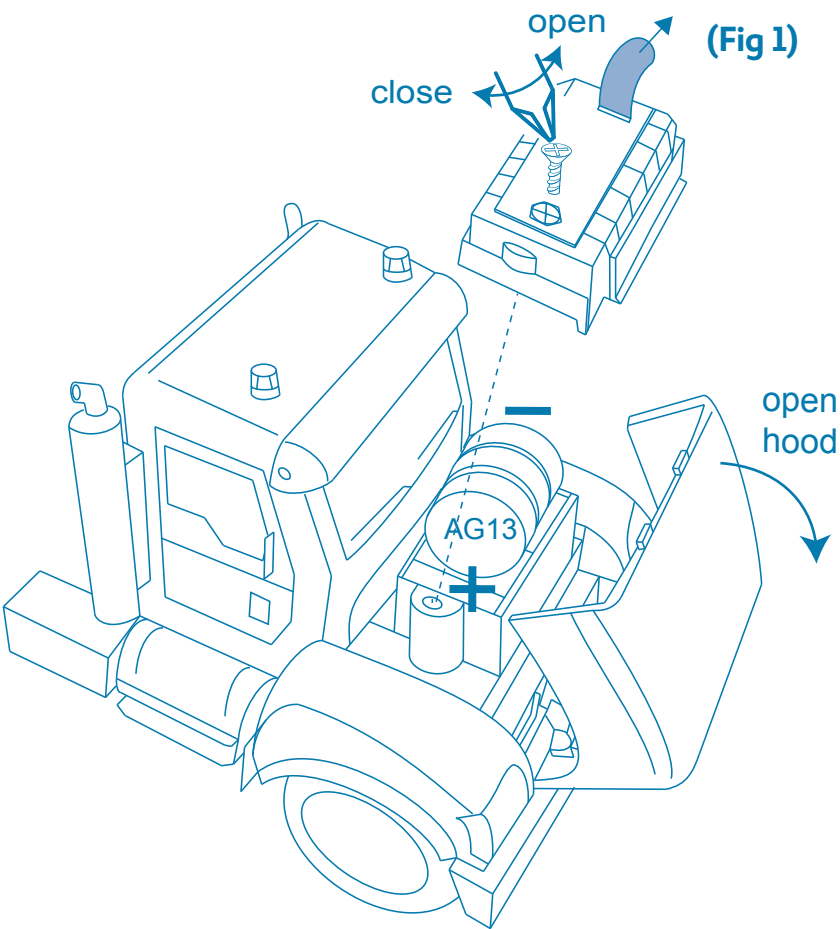

TO REPLACE BATTERIES



Before first use:

1. Pull out insulation tag as (Fig 1).
2. Press on roof for lights and sounds as (Fig 2).

3+
YEARS

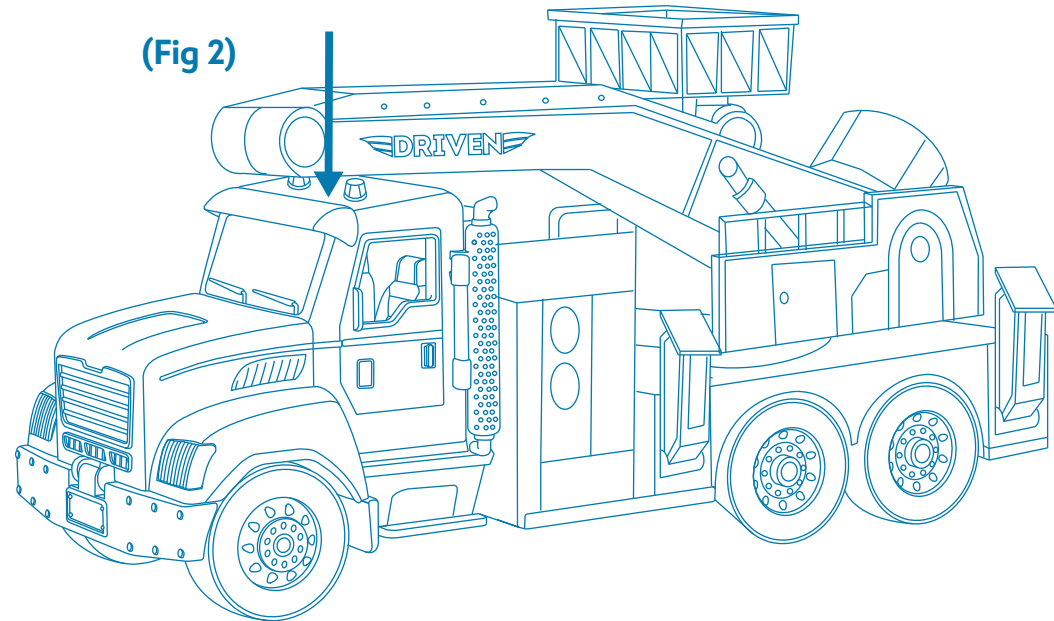

REPLACING BATTERIES

3 x AG13 (1.5V) BATTERIES INCLUDED

- Do not mix old and new batteries.
- Do not mix alkaline, standard(carbon-zinc), or rechargeable batteries.
- Dead batteries? Check out earth911.com to quickly find the recycling center nearest you.

⚠ WARNING: This product contains a Button or Coin Cell Battery. A swallowed Button or Coin Cell Battery can cause internal chemical burns leading to death in as little as two hours. Dispose of used batteries immediately. Keep new and used batteries away from children. If you think batteries might have been swallowed or placed inside any part of the body, seek immediate medical attention.

WH1128

This device complies with Part 15 of the FCC Rules. Operation is subject to the following two conditions: (1) this device may not cause harmful interference, and (2) this device must accept any interference received, including interference that may cause undesired operation.

Caution: changes or modifications not expressly approved by the party responsible for compliance could void the user's authority to operate the equipment.

NOTE: This equipment has been tested and found to comply with the limits for a Class B digital device, pursuant to Part 15 of the FCC Rules. These limits are designed to provide reasonable protection against harmful interference in a residential installation. This equipment generates, uses and can radiate radio frequency energy and, if not installed and used in accordance with the instructions, may cause harmful interference to radio communications. However, there is no guarantee that interference will not occur in a particular installation. If this equipment does cause harmful interference to radio or television reception, which can be determined by turning the equipment off and on, the user is encouraged to try to correct the interference by one or more of the following measures:

- Reorient or relocate the receiving antenna.
- Increase the separation between the equipment and receiver.
- Connect the equipment into an outlet on a circuit different from that to which the receiver is connected.
- Consult the dealer or an experienced radio/TV technician for help.

Please remove all packaging materials before giving to children.

Use alkaline batteries for longer play time.

ATTENTION: When the module's functions lose performance, follow instructions carefully to install new batteries.

⚠ WARNING:
CHOKING HAZARD - Small parts.
Not for children under 3 years.

- Rough or inappropriate usage may result in permanent damage to the toy.
- Excessive sand, dirt and/or water may cause the toy to malfunction.