

Stickers Application/Application des autocollants

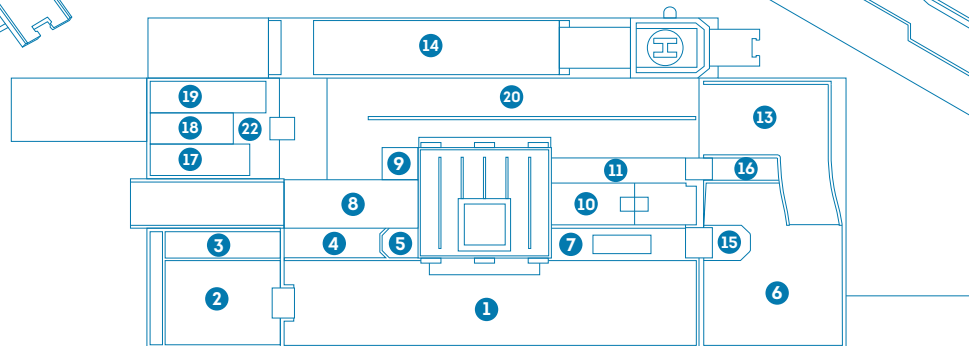
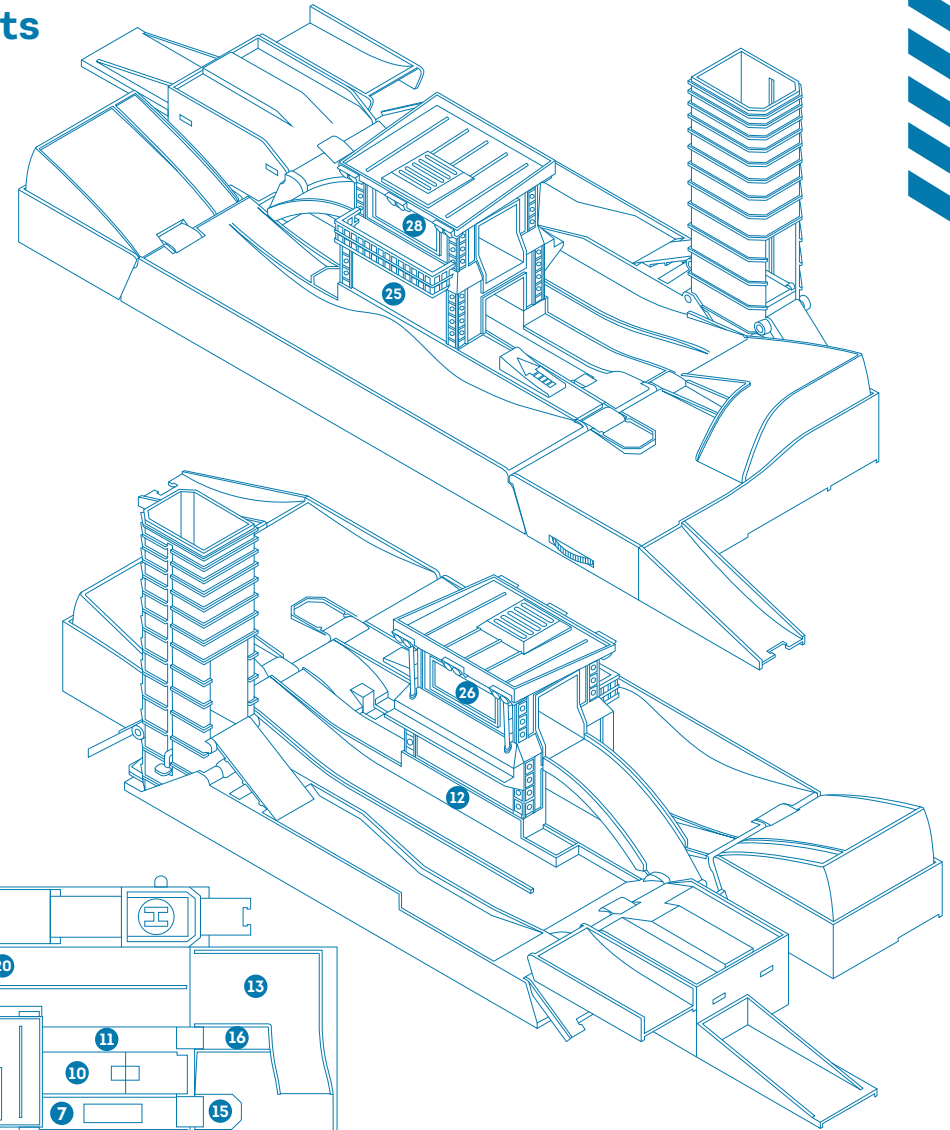
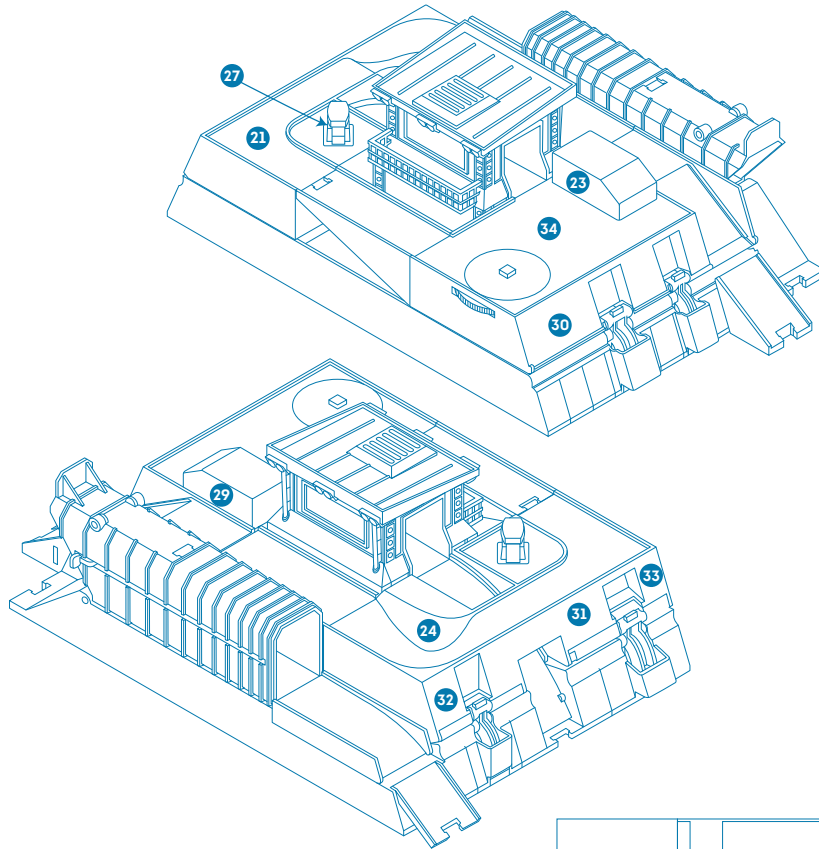

WH1108/WH1108Z

AVERTISSEMENT:
RISQUE DE SUFFOCATION -
Petites pièces. Ce produit n'est
pas recommandé pour
les enfants de 3 ans et moins.

WARNING:
CHOKING HAZARD - Small parts.
Not for children under 3 years.



WARNING: SMALL PARTS - CHOKING HAZARD. Not suitable for children under 3 years.
ATTENTION: PETITS ÉLÉMENTS - DANGER D'ÉTOUFFEMENT. Ne convient pas aux enfants de moins de 3 ans.
ACHTUNG: KLEINE TEILE - ERSTICKUNGSGEFAHR. Nicht für Kinder unter 3 Jahren geeignet.
¡ADVERTENCIA! PIEZAS PEQUEÑAS - PELIGRO DE ATRAGANTAMIENTO. No apropiado para niños menores de 3 años.
AVVERTENZA! RISCHIO DI SOFFOCAMENTO DI PICCOLE PARTI. Non adatto a bambini di età inferiore a 3 anni.
WAARSCHUWING! KLEINE ONDERDELEN - VERSTIKKINGGEVAAR. Niet geschikt voor kinderen jonger dan 3 jaar.

EN: Please remove all packaging materials before giving to children.
FR: Veuillez retirer tout l'emballage avant de donner le produit à des enfants.
DE: Vor Übergabe an Kinder bitte sämtliches Verpackungsmaterial entfernen.
ES: Por favor quita todos los materiales del embalaje antes de darlo a los niños.
IT: Per favore rimuovi tutti i materiali dell'imballaggio prima di darlo ai bambini.
NL: Verwijder de verpakking voordat het product aan een kind wordt gegeven.



Includes/Inclus

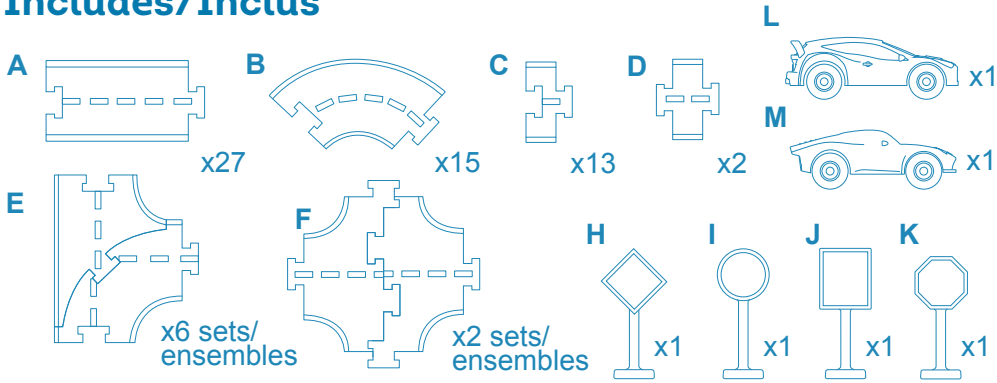

2 IN 1
TRANSFORMATION!
TRANSFORMATION
2-EN-1!

RAISE AND LOWER THE ELEVATOR/CAR WASH
FOR TRANSFORMATION
LÈVE ET ABASSE L'ASCENSEUR OU
LE LAVE-AUTO POUR VOIR LA TRANSFORMATION

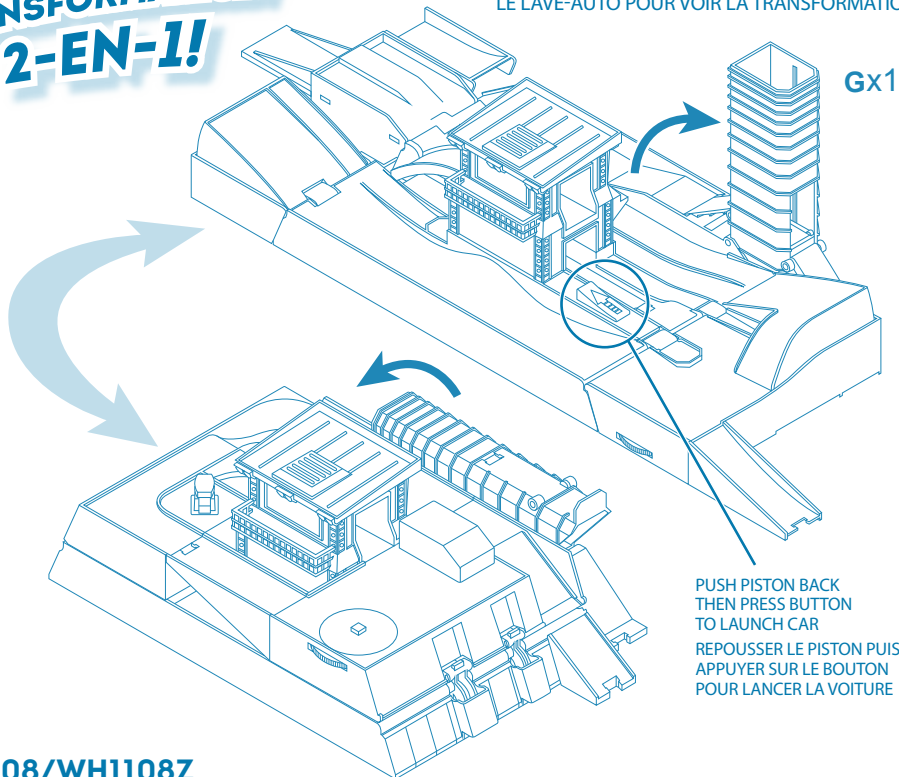

Track Layouts/Disposition des pistes

Layout/Disposition - A

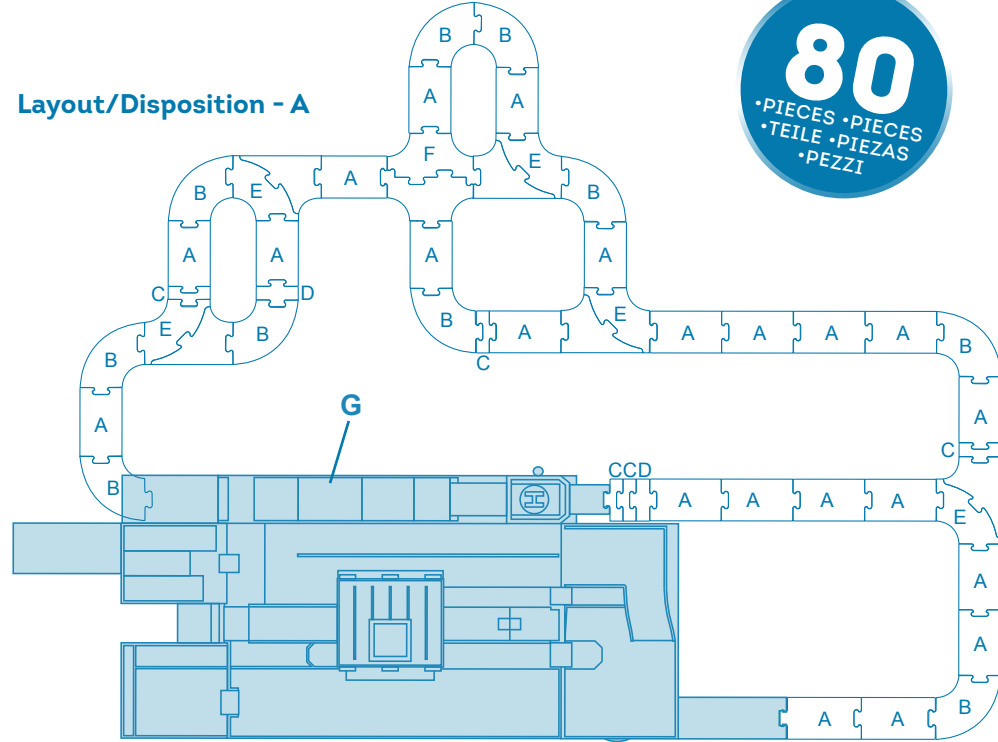

Layout/Disposition - B

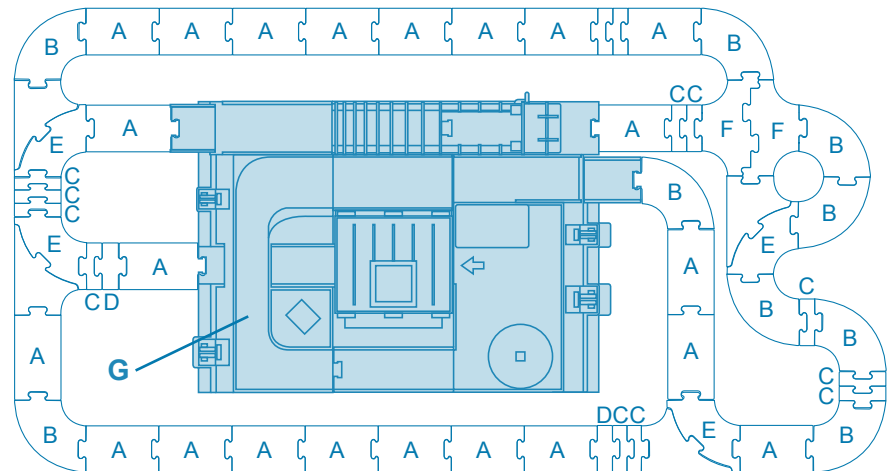

80
•PIECES •PIECES
•TEILE •PIEZAS
•PEZZI